

PROPRIETARY NOTE

THIS SPECIFICATION IS THE PROPERTY OF FANNAL AND SHALL NOT BE REPRODUCED OR COPIED WITHOUT THE WRITTEN PERMISSION OF FANNAL AND MUST BE RETURNED TO FANNAL UPON ITS REQUEST



SPEC. NUMBER AM-0800010B	PRODUCT GROUP TFT- LCM	REV. V0	ISSUE DATE 2022-8-10	PAGE 1 OF 24
-----------------------------	---------------------------	------------	-------------------------	-----------------

FN0800D010B

Product Specification Rev.V0

BUYER	
SUPPLIER	FANNAL Electronics CO., LTD
FG-Code	FN0800D010B

Preliminary Specification

Approval Specification

ITEM	BUYER SIGNATURE	DATE
_____	_____	_____
_____	_____	_____
_____	_____	_____

ITEM	SUPPLIER SIGNATURE	DATE
Prepare	<u> DONG </u>	<u>2022-08-10</u>
Reviewed	<u> Steven </u>	<u>2022-08-10</u>
Approved	<u> JACK </u>	<u>2022-08-10</u>

PRODUCT GROUP

REV

ISSUE DATE



TFT- LCM PRODUCT

V0

2022-8-10

SPEC. NUMBER

AM-0800010B

SPEC . TITLE

FN0800D010B Product Specification

PAGE

2 OF 24

REVISION HISTORY

REV.	ECN No.	DESCRIPTION OF CHANGES	DATE	PREPARED
V0		Initial Release	2022-8-10	JACK

PRODUCT GROUP

REV

ISSUE DATE



TFT- LCM PRODUCT

V0

2022-8-10

SPEC. NUMBER

SPEC. TITLE

PAGE

AM-0800010B

FN0800D010B Product Specification

3 OF 24

Contents

No.	Items	Page
1.0	General Description	4
2.0	Mechanical Drawing	5
3.0	Absolute Maximum Ratings	6
4.0	Electrical Specifications	7
5.0	Interface Description	9
6.0	Optical Specifications	14
7.0	Reliability Test	16
8.0	Precautions	17
9.0	Packing Information	21
10.0	Visual Inspection Criteria For All Customers	22

PRODUCT GROUP

REV

ISSUE DATE



TFT- LCM PRODUCT

V0

2022-8-10

SPEC. NUMBER

SPEC. TITLE

PAGE

AM-0800010B

FN0800D010B Product Specification

4 OF 24

1.0 General Description /一般说明

1.1 Application /应用

- Industrial
- Automotive
- Medical
- Outdoor highlight

1.2 General Specification /通用技术条件

The followings are general specifications at the FN0800D010B.

Parameter	Specification	Unit	Remarks
LCD size	8.0 inch(Diagonal)		
Number Of Pixels	800(H)RGB×480(V)	pixels	
Pixel Pitch	0.2208(H)×0.207(V)	mm	
Active Area	176.64(H)×99.36(V)	mm	
Display Mode	Normally White, Transmissive		
Module Size	192.8(W)×116.9(H)×6.4(D) (without PCB)	mm	
Driver element	a-Si TFT active matrix		
Surface treatment	Hard Coating (3H)		
Interface	LVDS		
Backlight Consumption	2.0(MAX.)	W	
Weight	220	g	
Luminance	500(Typ.)	cd/m ²	
Driver IC	HX8664-B+HX8264-E		

2.0 Mechanical Drawing /机械制图

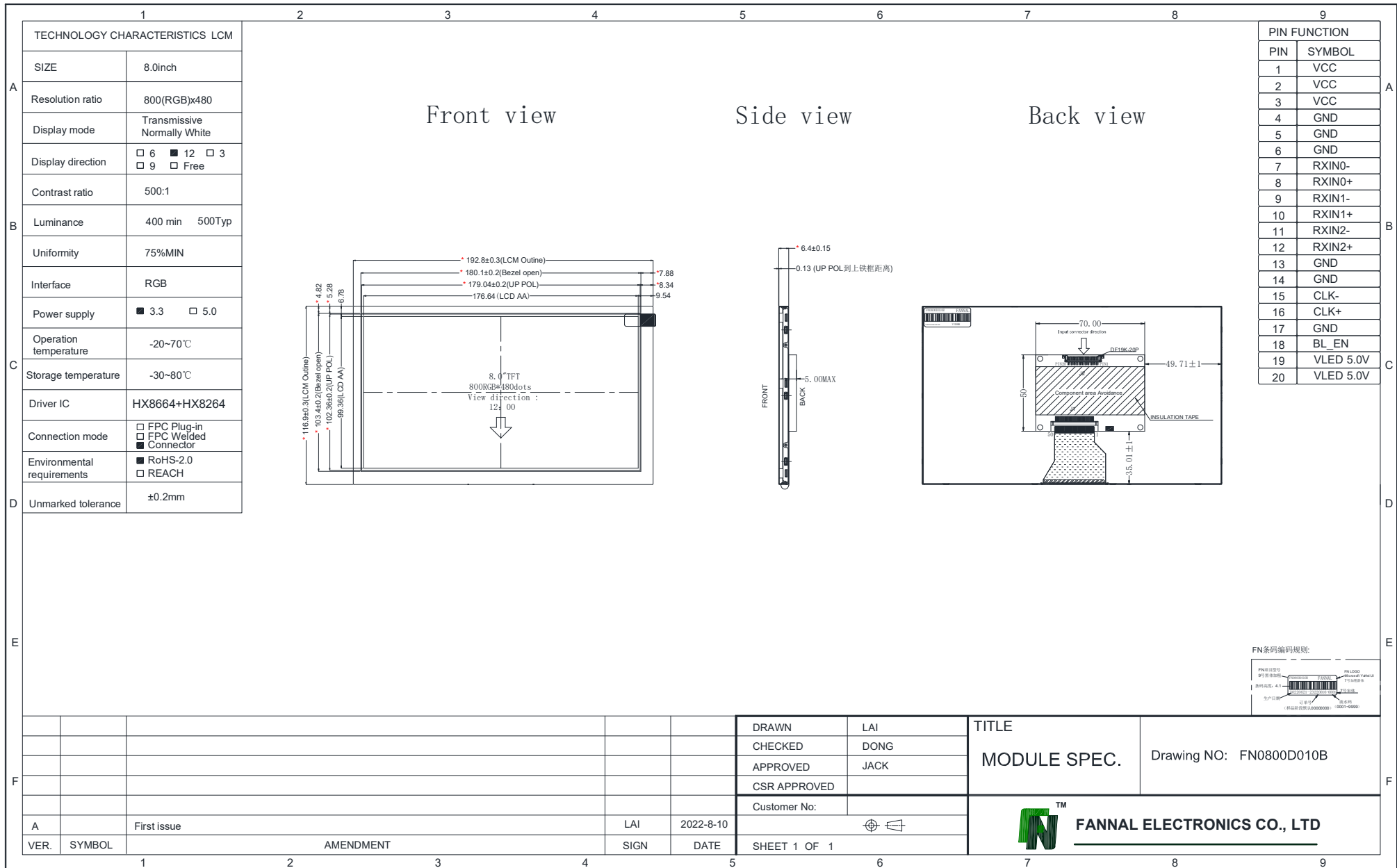

PRODUCT GROUP

REV

ISSUE DATE



TFT- LCM PRODUCT

V0

2022-8-10

SPEC. NUMBER

SPEC. TITLE

PAGE

AM-0800010B

FN0800D010B Product Specification

6 OF 24

3.0 ABSOLUTE MAXIMUM RATINGS /绝对最大额定值

The followings are maximum values which, if exceed, may cause faulty operation or damage to the unit.

[Ta =25±2 °C]

Parameter	Symbol	Min.	Max.	Unit
Power supply for LCD	VDD	-0.3	3.6	V
Operating Temperature	T _{OP}	-20	+70	°C
Storage Temperature	T _{ST}	-30	+80	°C

Note:

If the module is above these absolute maximum ratings. It may become permanently damaged. Using the module within the following electrical characteristic conditions are also exceeded, the module will malfunction and cause poor reliability.

PRODUCT GROUP

REV

ISSUE DATE



TFT- LCM PRODUCT

V0

2022-8-10

SPEC. NUMBER

SPEC. TITLE

PAGE

AM-0800010B

FN0800D010B Product Specification

7 OF 24

4.0 ELECTRICAL SPECIFICATIONS/电气规范

4.1 Typical Operation Conditions

[Ta =25±2 °C]

Parameter	Symbol	Min.	Typ.	Max.	Unit	Note
Power supply for LCD	VDD	3.0	3.3	3.6	V	
Power supply for LCD	IDD	-	4.0	-	mA	
Voltage for Backlight	VLED	2.7	5.0	5.5	V	
BL_EN		2.7	-	5.5	V	
Input logic high voltage	VIH	0.7VDD	-	VDD	V	
Input logic low voltage	VIL	0	-	0.3VDD	V	

Note 1: Be sure to apply VDD and VGL to the LCD first, and then apply VGH.

Note 2: VDD setting should match the signals output voltage of customer's system board.

PRODUCT GROUP

REV

ISSUE DATE



TFT- LCM PRODUCT

V0

2022-8-10

SPEC. NUMBER

SPEC. TITLE

PAGE

AM-0800010B

FN0800D010B Product Specification

8 OF 24

4.2 Backlight Driving Conditions /背光驱动条件

[Ta =25±2 °C]

Parameter	Symbol	Min.	Typ.	Max.	Unit	Notes
Forward Voltage	V _F	--	5.0	--	V	Note 1
LED Life Time	l _t	--	30000	--	Hrs	Note 2

Note1: Under LCM operating, the stable forward current should be inputted. And forward voltage is for reference only.

Note2: If LED is driven by high current, high ambient temperature & Humidity condition. The life time of LED will be reduced. Operating life means brightness goes down to 50% initial brightness. Typical operating life time is estimated data.

5.0 Interface Description/接口说明

Connector Name/Designation	Interface Connector/Interface Card
Type Part Number	DF19K-20P-1H
Mating Housing Part Number	DF19-20S-1C

5.1 Pin assignment for LCM module /模组引脚分配

Pin No.	Symbol	Description
1	VDD	Power Supply
2	VDD	Power Supply
3	VDD	Power Supply
4	GND	Ground.
5	GND	Ground.
6	GND	Ground.
7	RXIN0-	LVDS Negative data signal(-)
8	RXIN0+	LVDS Positive data signal(+)
9	RXIN1-	LVDS Negative data signal(-)
10	RXIN1+	LVDS Positive data signal(+)
11	RXIN2-	LVDS Negative data signal(-)
12	RXIN2+	LVDS Positive data signal(+)
13	GND	Ground.
14	GND	Ground.
15	CLK-	LVDS Negative CLK signal(-)
16	CLK+	LVDS Positive CLK signal(+)
17	GND	Ground.
18	BL_EN	Backlight enable ON/OFF
19	VLED 5.0V	Power for LED backlight
20	VLED 5.0V	Power for LED backlight

5.2 Interface timing Parameter /接口时序参数

Power ON:

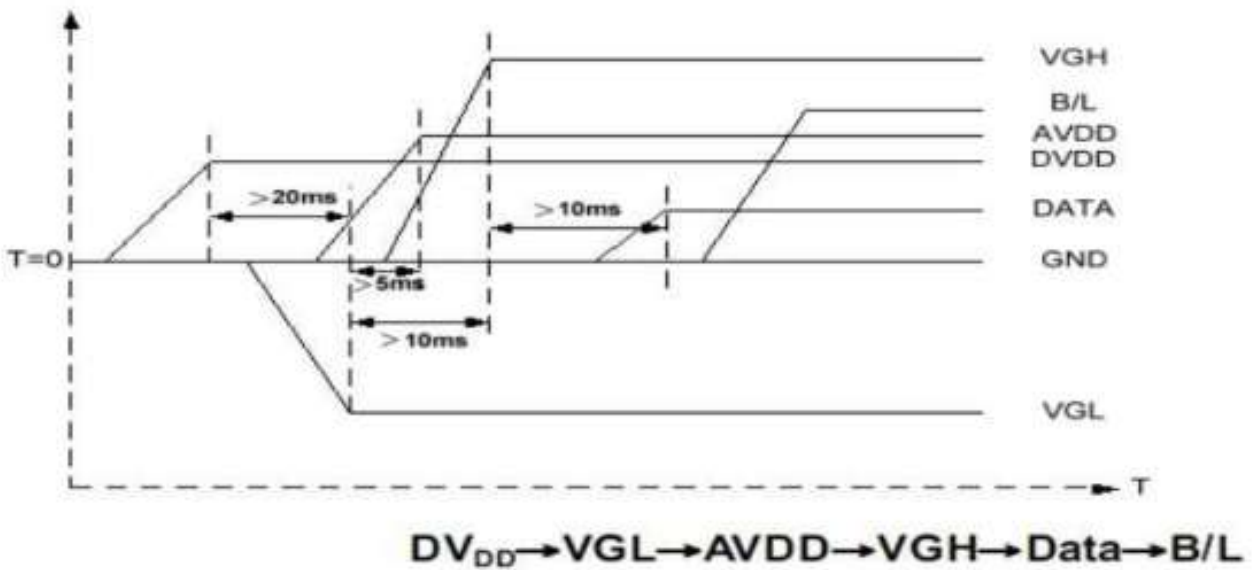

Power OFF:

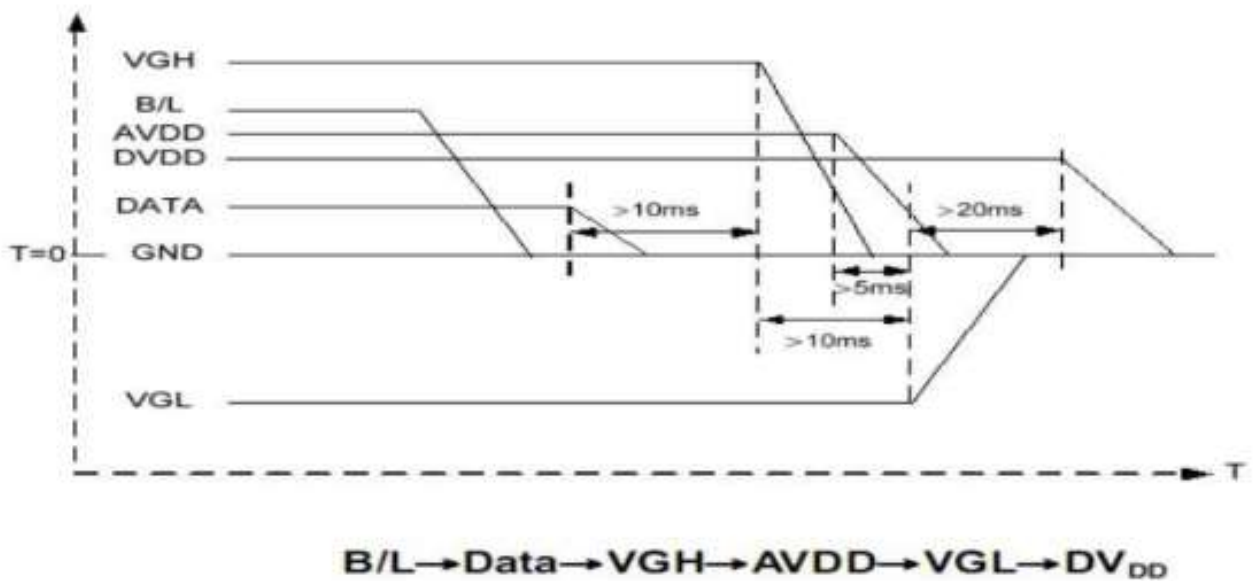

Note: Data include R0~R7, B0~B7, GO~G7, U/D, L/R, DCLK, HS,VS,DE.

5.3 Timing Characteristics

AC Electrical Characteristics

Item	Symbol	Value			Unit	Remark
		Min	Typ	Max		
Hs setup time	T_{HST}	8			ns	
Hs hold time	T_{HHD}	8			ns	
VS setup time	T_{VST}	8			ns	
VS hold time	T_{VHD}	8			ns	
Data setup time	T_{DSU}	8			ns	
Data hold time	T_{DHD}	8			ns	
DE setup time	T_{ESU}	8			ns	
DE hold time	T_{EHD}	8			ns	
DVDD power on slew rate	T_{POR}	-		20	ms	
RESET pulse width	T_{RST}	1			ms	
DCLK cycle time	T_{COH}	20			ns	
DCLK pulse duty	T_{CWH}	40	50	60	%	

input Clock and Data Timing Diagram

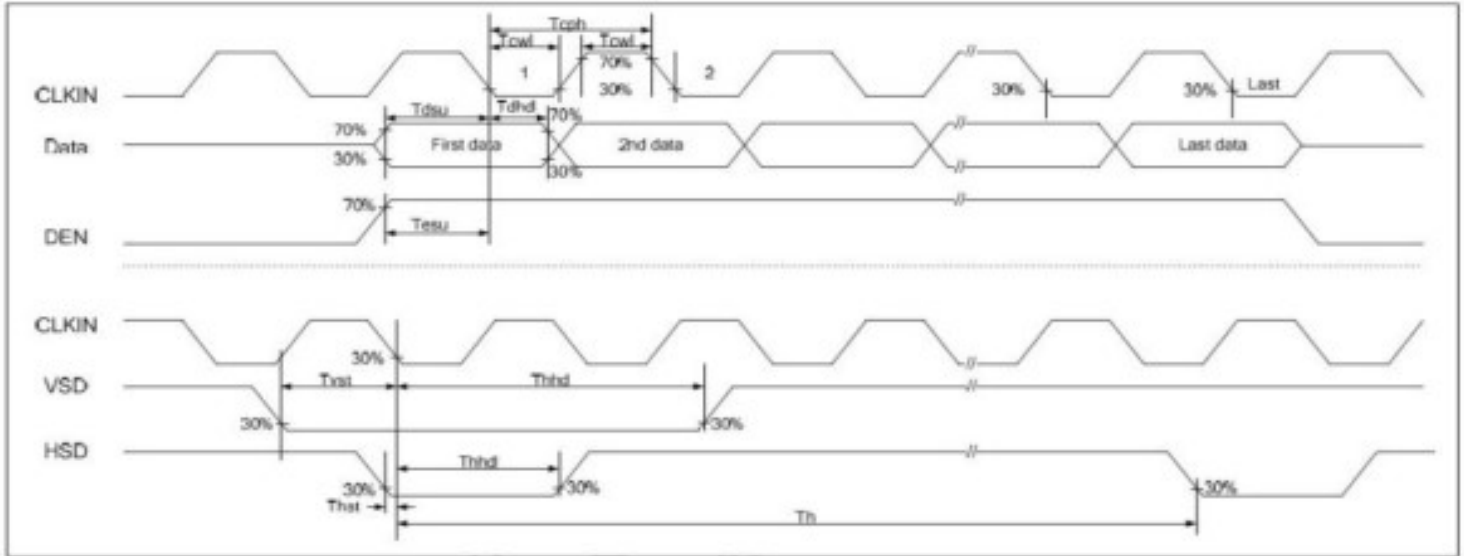

Timing

Item	Symbol	Values			Unit	Remark
		Min.	Typ.	Max.		
Horizontal Display Area	thd	-	800	-	DCLK	
DCLK Frequency	fclk	26.4	33.3	46.8	MHz	
One Horizontal Line	th	862	1056	1200	DCLK	
HS pulse width	thpw	1	-	40	DCLK	
HS Blanking	thb	46	46	46	DCLK	
HS Front Porch	thfp	16	210	354	DCLK	

Item	Symbol	Values			Unit	Remark
		Min.	Typ.	Max.		
Vertical Display Area	tvd	-	480	-	TH	
VS period time	tv	510	525	650	TH	
VS pulse width	tvpw	1	-	20	TH	
VS Blanking	tvb	23	23	23	TH	
VS Front Porch	tvfp	7	22	147	TH	

Horizontal input timing diagram

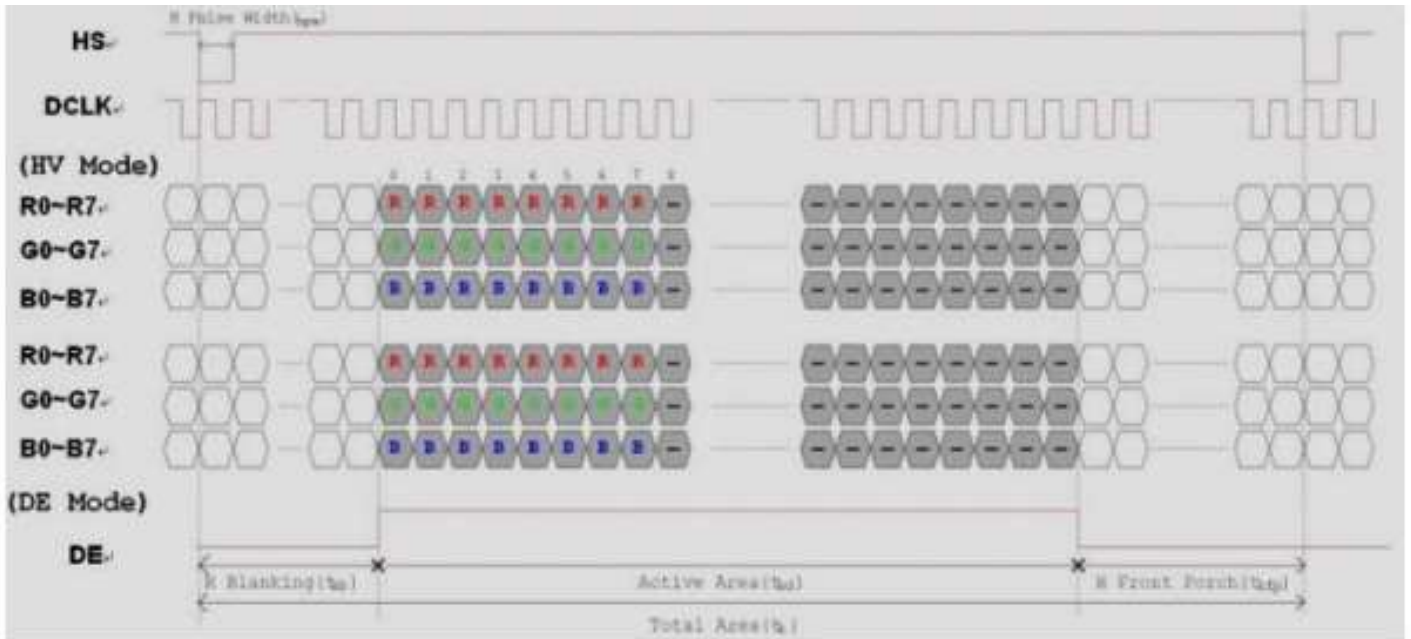

Vertical input timing diagram

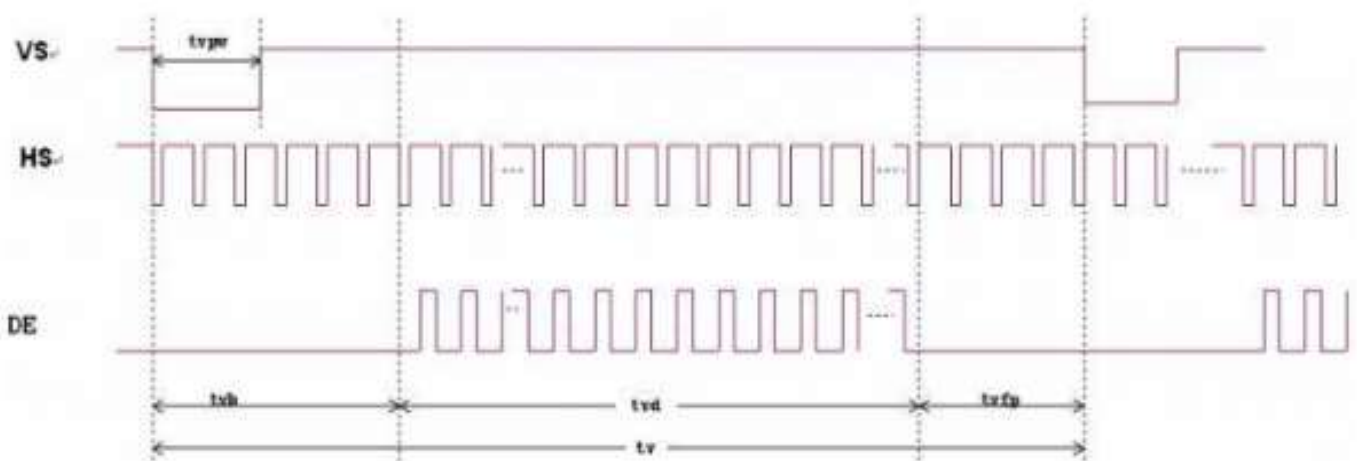

6.0 OPTICAL SPECIFICATIONS /光学规格

6.1 Overview /概述

The test of optical specifications shall be measured in a dark room (ambient luminance ≤ 1 lux and temperature = $25 \pm 2^\circ\text{C}$) with the equipment of Luminance meter system (Goniometer system and TOPCON BM-5) and test unit shall be located at an approximate distance 50cm from the LCD surface at a viewing angle of θ and ϕ equal to 0° . We refer to $\theta=0$ ($=\theta_3$) as the 3 o'clock direction (the "right"), $\theta=90$ ($=\theta_{12}$) as the 12 o'clock direction ("upward"), $\theta=180$ ($=\theta_9$) as the 9 o'clock direction ("left") and $\theta=270$ ($=\theta_6$) as the 6 o'clock direction ("bottom"). While scanning θ and/or ϕ , the center of the measuring spot on the display surface shall stay fixed.

6.2 Optical Specifications /光学规格

Item	Symbol	Condition	Min	Typ.	Max	Unit	Note
Viewing Angle	θ_L	$Cr \geq 10$	60	70	--	deg	Note 1
	θ_R		60	70	--		
	ψ_T		40	50	--		
	ψ_B		60	70	--		
Contrast Ratio	Cr	$\theta=0^\circ$	--	500	--	-	Note 2
Response Time	$Tr+Tf$	$FF=0^\circ$	--	25	50	ms	Note 3
Color Coordinate of CIE1931	W_x	$\theta=0^\circ$	Typ -0.03	0.311	Typ +0.03	-	Note 4
	W_y			0.343			
	R_x			0.589			
	R_y			0.332			
	G_x			0.143			
	G_y			0.131			
	B_x			0.308			
	B_y			0.558			
Uniformity	U		75	80		%	Note 5
Luminance	L		400	500	-	cd/m ²	Note 6

Note 1: The definition of Viewing Angle

Refer to the graph below marked by θ and ϕ .

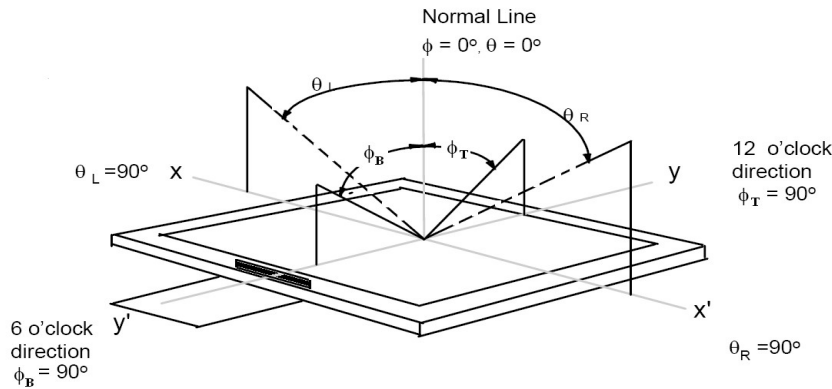

Note 2: The definition of Contrast Ratio

$$\text{Contrast Ratio (CR)} = \frac{\text{Luminance When LCD is at "White" state}}{\text{Luminance When LCD is at "Black" state}}$$

(Contrast Ratio is measured in optimum common electrode voltage)

Note 3: Definition of Response time. (Test LCD using RD80S or similar equipments):

The output sign also photo detector are measured when the input sign also are changed from "black" to "white" (Voltage falling time) and from "white" to "black" (Voltage rising time), respectively. The response time is defined as the time interval between the 10% and 90% of amplitudes. Refer to figures below.

Note 4: Color Coordinates of CIE 1931

The test condition is at ILED=20mA and measured on the surface of LCD module at 25°C.

Measurement equipment: CS2000 or similar equipments

The Color Coordinate (CIE 1931) is the measurement of the center of the display shown in below figure.

Note 5: Definition of Color of CIE Coordinate and NTSC Ratio.

$$S = \frac{\text{area of RGB triangle}}{\text{area of NTSC triangle}} \times 100\%$$

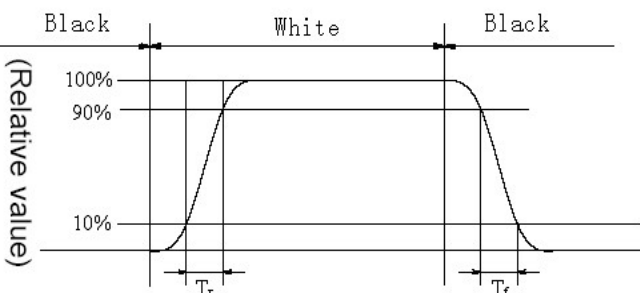

Note 3

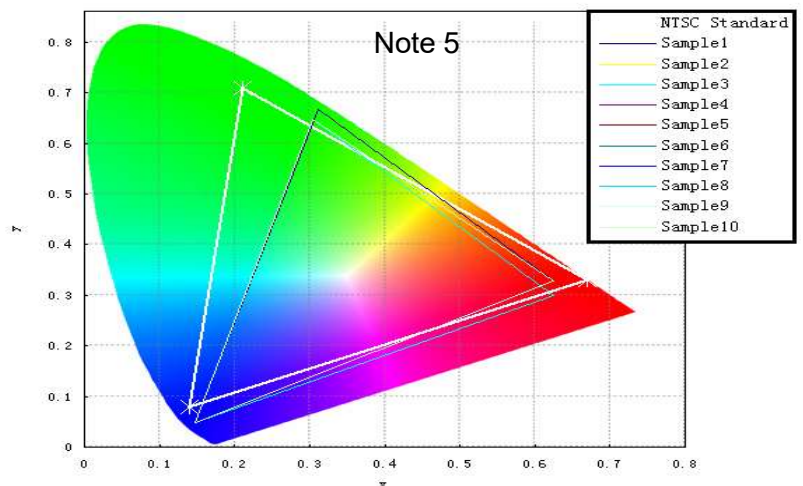

7.0 RELIABILITY TEST /可靠性测试

The Reliability test items and its conditions are shown in below.

No	Test Items	Conditions	Testing standard
1	High temperature storage test	80°C 240hr	IEC60068-2-1:2007 GB2423.2-2008
2	Low temperature storage test	-30°C 240hr	
3	Low temperature operation test	-20°C 240hr	
4	High temperature operation test	70°C 240hr	
5	High temperature & humidity (storage test)	60°C 90%RH 240hr	IEC60068-2-78:2001 GB/T2423.3-2006
6	Thermal Shock Test	-30°C~80°C 1hr/cycle 10cycle	Start with cold temperature End with high temperature IEC60068-2-14:1984, GB2423.22-2002
7	Vibration Test	10Hz-55Hz 100m/s ² 120min	IEC60068-2-32:1990 GB/T2423.8-1995
8	Mechanical shock	100G ±X, ±Y, ±Z, 3times for each direction	
9	Dropping test	Height: 60 cm, 1 corner, 3 edges, 6 surfaces	
10	ESD test	C=150pF, R=330 Ω, 5 points/panel Air:±8KV, 5 times; Contact: ±4KV, 5 times;	IEC61000-4-2:2001 GB/T17626.2-2006 Class C

PRODUCT GROUP	REV	ISSUE DATE	
TFT- LCM PRODUCT	V0	2022-8-10	
SPEC. NUMBER AM-0800010B	SPEC. TITLE FN0800D010B Product Specification		PAGE 17 OF 24

- **8.0 Precautions /注意事项**

- Please pay attention to the followings when you use this TFT LCD Panel.

- **8.1 Mounting Precautions /安装注意事项**

- (1) Use fingerstalls with soft gloves in order to keep display clean during the incoming inspection and assembly process.
- (2) You must mount a module using specified mounting holes (Details refer to the drawings).
- (3) Please make sure to avoid external forces applied to the Source PCB or FPC and D-IC during the process of handling or assembling. If not, It causes panel damage or malfunction.
- (4) Note that polarizers are very fragile and could be easily damaged. Do not touch, push or rub the exposed polarizers with glass, tweezers or anything harder than HB pencil lead. And please do not rub with dust clothes with chemical treatment.
- (5) Do not pull or fold the source D-IC which connect the source PCB or FPC and the panel.
- Do not pull or fold the LED wire.
- (6) After removing the protective film, when the surface becomes dusty, please wipe gently with absorbent cotton or other soft materials like chamois soaks with alcohol or purified water.
- Do not strong polar solvent because they cause chemical damage to the polarizer.
- (7) Wipe off saliva or water drops as soon as possible. Their long time contact with polarizer causes deformations and color fading.
- (8) Protection film for polarizer on the module shall be slowly peeled off just before use so that the electrostatic charge can be minimized.
- (9) Since the LCD is made of glass, do not apply strong mechanical impact or static load onto it. Handling with care since shock, vibration, and careless handling may seriously affect the product. If it falls from a high place or receives a strong shock, the glass may be broken.
- (10) Do not disassemble the module.
- (11) To determine the optimum mounting angle, refer to the viewing angle range in the specification for each model.
- (12) If the customer's set presses the main parts of the LCD, the LCD may show the abnormal display. But this phenomenon does not mean the malfunction of the LCD and should be pressed by the way of mutual agreement.
- (13) Do not drop water or any chemicals onto the LCD's surface.

PRODUCT GROUP	REV	ISSUE DATE	
TFT- LCM PRODUCT	V0	2022-8-10	
SPEC. NUMBER	SPEC. TITLE		PAGE
AM-0800010B	FN0800D010B Product Specification		18 OF 24

8.2 Operating Precautions /操作注意事项

- (1) Be careful for condensation at sudden temperature change. Condensation makes damage to polarizer or electrical contacted parts. And after fading condensation, smear or spot will occur.
- (2) Module has high frequency circuits. Sufficient suppression to the electromagnetic interference shall be done by system manufacturers. Grounding and shielding methods may be important to minimized the interference.
- (3) The electrochemical reaction caused by DC voltage will lead to LCD degradation, so DC drive should be avoided.
- (4) The LCD modules use C-MOS LSI drivers, so customers are recommended that any unused input terminal would be connected to Vdd or Vss, do not input any signals before power is turn on, and ground you body, work/assembly area, assembly equipments to protect against static electricity.
- (5) Do not exceed the absolute maximum rating value. (supply voltage variation, input voltage variation, variation in part contents and environmental temperature, and so on) Otherwise the Module may be damaged.
- (6) Design the length of cable to connect between the connector for back-light and the converter as short as possible and the shorter cable shall be connected directly.
The longer cable between that of back-light and that of converter may cause the luminance of LED to lower and need a higher startup voltage(Vs).
- (7) Connectors are precise devices for connecting PCB and transmitting electrical signals. Operators should insert and unplug MDL in parallel when assembling MDL.
- (8) Do not connect or disconnect the cable to/ from the module at the "Power On" condition.
- (9) When the module is operating, do not lose CLK, ENAB signals. If any one these signals is lost, the LCD panel would be damaged.
- (10) Obey the supply voltage sequence. If wrong sequence is applied, the module would be damaged.
- (11) Do not re-adjust variable resistor or switch etc.
- (12) For the Q/Single/OC Product, If the LED designed side view, LED bar should be putted in the Long/short side ; Otherwise, its reliability and function may not be guaranteed.

注：
 ①(1)涉及到Pol相关条目适用于OC/MDL出货产品，
 ②(6)(7)涉及到connector相关适用于OC/MDL出货产品
 ③ (12) 涉及到客户进行BLU设计， LED Bar位置需要避开GOA位置；

8.3 Electrostatic Discharge Control /静电放电控制

- (1) Since a module is composed of electronic circuits, it is not strong to electrostatic discharge. Make certain that treatment persons are connected to ground through wrist band etc. And don't touch interface pin directly. Keep products as far away from static electricity as possible.
- (2) Avoid the use work clothing made of synthetic fibers. We recommend cotton clothing or other conductivity-treated fibers.

PRODUCT GROUP		REV	ISSUE DATE	
TFT- LCM PRODUCT		V0	2022-8-10	
SPEC. NUMBER	SPEC. TITLE			PAGE
AM-0800010B	FN0800D010B Product Specification			19 OF 24

8.4 Precautions for Strong Light Exposure / 强光照射注意事项

It is not allowed to store or run directly in strong light or in high temperature and humidity for a long time; Strong light exposure causes degradation of polarizer and color filter.

8.5 Storage Precautions / 存储注意事项

When storing modules as spares for a long time, the following precautions are necessary.

- (1) The polarizer surface should not come in contact with any other object.
It is recommended that they be stored in the container in which they were shipped.
Temperature : 5 ~ 40 °C
- (2) Humidity : 35 ~ 75 %RH
- (3) Period : 6 months
- (4) Control of ventilation and temperature is necessary.
- (5) Please make sure to protect the product from strong light exposure, water or moisture.
Be careful for condensation.
- (6) Store in a polyethylene bag with sealed so as not to enter fresh air outside in it.
- (7) Do not store the LCD near organic solvents or corrosive gasses.
- (8) Please keep the Modules/OC/FOG at a circumstance shown below Fig.

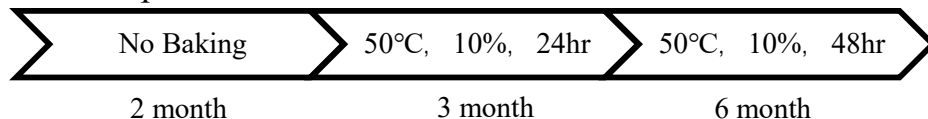

8.6 Precautions for Protection Film / 保护膜注意事项

- (1) Remove the protective film slowly, keeping the removing direction approximate 30-degree not vertical from panel surface, If possible, under ESD control device like ion blower, and the humidity of working room should be kept over 50%RH to reduce the risk of static charge.
- (2) In handling the LCD, wear non-charged material gloves. And the conducting wrist to the earth and the conducting shoes to the earth are necessary.

8.7 Appropriate Condition for Display / 适当的显示条件

- (1) Normal operating condition
 - Temperature: 0 ~ 40°C
 - Operating Ambient Humidity : 10 ~ 90 %
 - Display pattern: dynamic pattern (Real display)
 - Suitable operating time: under 12 hours a day.
- (2) Special operating condition
If the product will be used in extreme conditions such as high temperature, humidity, display patterns or 7*24hrs operation time etc., It is strongly recommended to contact us for Application engineering advice. Otherwise, its reliability and function may not be guaranteed.
- (3) Black image or moving image is strongly recommended as a screen save.

PRODUCT GROUP	REV	ISSUE DATE	
TFT- LCM PRODUCT	V0	2022-8-10	
SPEC. NUMBER	SPEC. TITLE		PAGE
AM-0800010B	FN0800D010B Product Specification		20 OF 24

- (4) Lifetime in this spec. is guaranteed only when commercial display is used according to operating usages.
- (5) Please contact us in advance when you display the same pattern for a long time.
- (6) If the Module keeps displaying the same pattern for a long period of time, the image may be “sticked“ or “turn off” to the screen. To avoid image sticking, it is recommended to use a screen saver.
- (7) Do not exceed the absolute maximum rating value. (supply voltage variation, input voltage variation, variation in part contents and environmental temperature, and so on) Otherwise the Module may be damaged.
- (8) Dew drop atmosphere should be avoided.
- (9) The storage room should be equipped with a good ventilation facility and avoid to expose to corrosive gas , which has a temperature controlling system.
- (10) The LCD should be avoided to expose to corrosive gas for long time, ,the LCD may be affected by the gas as SO₂ ,H₂S etc.
- (11) When expose to drastic fluctuation of temperature (hot to cold or cold to hot) ,the LCD may be affected; Specifically, drastic temperature fluctuation from cold to hot ,produces dew on the LCD's surface which may affect the operation of the polarizer and the LCD.
- (12) Response time will be extremely delayed at lower temperature than the operating temperature range and on the other hand at higher temperature LCD may turn black at temperature above its operational range. However those phenomena do not mean malfunction or out of order with the LCD. The LCD will revert to normal operation once the temperature returns to the recommended temperature range for normal operation

8.8 Others /其他

A. LC Leak /液晶泄露

- If the liquid crystal material leaks from the panel, it is recommended to wash the LC with acetone or ethanol and then burn it.
- In case of contact with hands, skin or clothes, it has to be washed away thoroughly with soap.
- If LC in mouth, mouth need to be washed, drink plenty of water to induce vomiting and follow medical advice.
- If LC touch eyes, eyes need to be washed with running water at least 15 minutes.

B. Rework /返工

- When returning the module for repair or etc., Please pack the module not to be broken. We recommend to use the original shipping packages.

- C. In order to prevent potential problems, flicker should be adjusted by optimizing the Vcom value in customer LCM Line (适用于Q/Single/OC出货产品)

PRODUCT GROUP	REV	ISSUE DATE	
TFT- LCM PRODUCT	V0	2022-8-10	
SPEC. NUMBER AM-0800010B	SPEC. TITLE FN0800D010B Product Specification		PAGE 21 OF 24

9.0 PACKING INFORMATION(产品形态: LCM)

TBD

10.0 VISUAL INSPECTION CRITERIA FOR ALL CUSTOMERS /所有客户的目视检查标准

10.1 Sampling Method /抽样方法

Unless otherwise agreed upon in writing, the sampling inspection shall be applied to the Customers incoming inspection.

- 10.1.1 Lot size : 1 pallet per same model
- 10.1.2 Sampling type : Random sampling
- 10.1.3 Inspection level : II
- 10.1.4 Sampling table : MIL-STD-105E

10.2 Inspection Environment /检验环境

10.2.1 Ambient conditions

- a. Ambient Temperature: $25 \pm 3^{\circ}\text{C}$
- b. Relative Humidity: $65 \pm 20\% \text{RH}$
- c. Ambient Illumination: 300-700LUX (Normal: 500LUX)

10.2.2 Viewing Distance

The distance between the LCM and the inspector's eyes shall be at least 30cm-50cm

10.2.3 Viewing Angle

performing in front of the panel

[Vertical] : $\pm 25^{\circ}$

[Horizontal] : $\pm 40^{\circ}$

10.2.4 Inspection Area:

Display Area (Active Area)

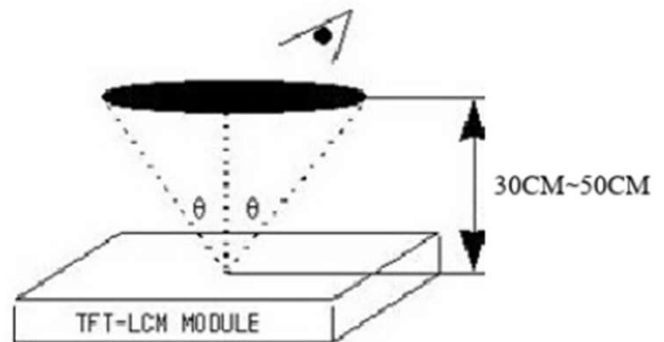

10.3 Definitions /定义

10.3.1 Dark / Bright Spots

Points on display which appear dark/bright and usually result from the contamination.

These defects do not vary in size or intensity (contrast) when contrast is varied.

10.3.2 Dark / Bright Lines

Lines on display which appear dark/bright and usually result from the contamination.

10.3.3 Polarizer Scratch

Lines on display which are seen across a darker background and do not vary in size.

10.3.4 Polarizer Dent

White spots on display which appear against a darker background and do not vary in size.

10.3.5 Bright Dot Defects

Dots (sub-pixels) on display which appear bright in the display area and visible through the 5%ND filter at Black Pattern.

PRODUCT GROUP	REV	ISSUE DATE	
TFT- LCM PRODUCT	V0	2022-8-10	
SPEC. NUMBER AM-0800010B	SPEC. TITLE FN0800D010B Product Specification		PAGE 23 OF 24

10.3.6 Dark Dot Defects

Dots(sub-pixels)on display which appear dark in the display area at R.G.B Color Pattern.

10.3.7 Line Defects

All line defects on display which appear bright/dark such as vertical, horizontal, or cross lines.

10.3.8 Mura

Mura on display which appears darker/brighter against background brightness on parts of display area.

10.3.9 BM Defects

Bright(white)Points on display which are off BM(Black Matrix).

10.3.10 Visual Inspection

Inspection for LCM when the unit turns on.

10.3.11 Appearance Inspection

External inspection for LCM when the unit turns off.

10.3.12 Other

Defects which cannot be classified into the above defect definitions.

Note 1: Bright& Dark dots are not smaller than a sub-pixel(Dots smaller than a sub-pixel are not counted as defect dots)

10.4 Inspection Criteria /检验标准

Refer to 《TFT LCM general inspection standard》

10.5 Verification /验证

The supplier can verify the defective LCMs to segregate the responsibilities at customer's facility or can request the Customer to ship the defective LCMs to assigned place for verification

This verification result shall be agreed mutually by the Customer and Supplier. This result can be corrected/changed after detail failure analysis at Supplier's facilities.

10.6 Supplier Induced Defects /供应商引起的缺陷

All of the Supplier induced defective LCMs shall be returned to the Supplier for repair or replacement.

Before return the defective LCMs, the Customer needs Supplier's confirmation with RMA Number.

All of the returned LCMs shall be returned to the Customer within agreed time period.

PRODUCT GROUP	REV	ISSUE DATE	
TFT- LCM PRODUCT	V0	2022-8-10	
SPEC. NUMBER AM-0800010B	SPEC. TITLE FN0800D010B Product Specification		PAGE 24 OF 24

10.7 Customer Induced Defects /顾客引起的缺陷

The Customer can return the customer induced defective LCMs to the Supplier for repair. The repair cost for Customer induced defective LCMs shall be agreed with both parties, Customer and Supplier.

10.8 Warranty Period /质量保证期

In-warranty period is Eighteen(18)Months from manufacturing month of LCM

Note :

- a. Eighteen months are composed of twelfth months in-warranty period and sixth months distribution period
- b. The manufacturing Month is on the LCMs as Supplier's serial No.

10.9 Repair Warranty /维修保证书

Repair warranty is Twelve(12)Months from repaired month for repaired LCMs

Note : a. The Label for repair will be added after repairing.

10.10 Warranty avoidance /避免担保

The warranty will be avoided in cases of below:

- a. When the warranty period is expired.
- b. The Customer induced defective LCMs.
- c. When the LCMs were repaired by 3rd party without Supplier's approval.
- d. When the LCMs were treated like Disassemble and Rework by the Customer and/or Customer's representatives without Supplier's approval.

10.11 Others /其他

If any problems arise with the LCMs supplied by supplier, the customer and supplier will cooperate and make efforts to solve it with mutual confidence and respect